

Model: HTS93G

Installation

EN

! It is important to conserve this booklet for consultation at any moment. In the case of sale, cession or move, make sure it is together with the product.

! Read the instructions carefully: there is important information about installation, use and safety.

! Do not carry out electrical or mechanical variations on the product or on the discharge conduits.

! Your hood is ready to be used in the suction version. To use the filtering version, you must order the suitable kit where you will find all the necessary details. The information for transforming the hood from the suction version to the filtering version is already contained in the manual supplied with the product.

Installation

Electrical connection

The mains power supply must correspond to the rating indicated on the plate situated inside the hood. If provided with a plug connect the hood to a socket in compliance with current regulations and positioned in an accessible area. If it not fitted with a plug (direct mains connection) or if the plug is not located in an accessible area apply a bi-polar switch in accordance with standards which assures the complete disconnection of the mains under conditions relating to over-current category III, in accordance with installation instructions.

Warning! Before re-connecting the hood circuit to the mains supply and checking the efficient function, always check that the mains cable is correctly assembled.

Connection to a discharge tube

Connect the hood and discharge holes on the walls with a diameter equivalent to the air outlet (connection flange).

Using the tubes and discharge holes on walls with smaller dimensions will cause a diminution of the suction performance and a drastic increase in noise. Any responsibility in the matter is therefore declined.

! The company declines any responsibility whenever these regulations are not respected.

The minimum distance between the supporting surface for the cooking vessels on the hob and the lowest part of the range hood must be not less than 50cm from electric cookers and 65cm from gas or mixed cookers. If the instructions for installation for the gas hob specify a greater distance, this must be adhered to.

Expansion wall plugs are provided to secure the hood to most types of walls/ceilings. However, a qualified technician must verify suitability of the materials in accordance with the type of wall/ceiling. The wall/ceiling must be strong enough to take the weight of the hood. **Do not tile, grout or silicone this appliance to the wall. Surface mounting only.**

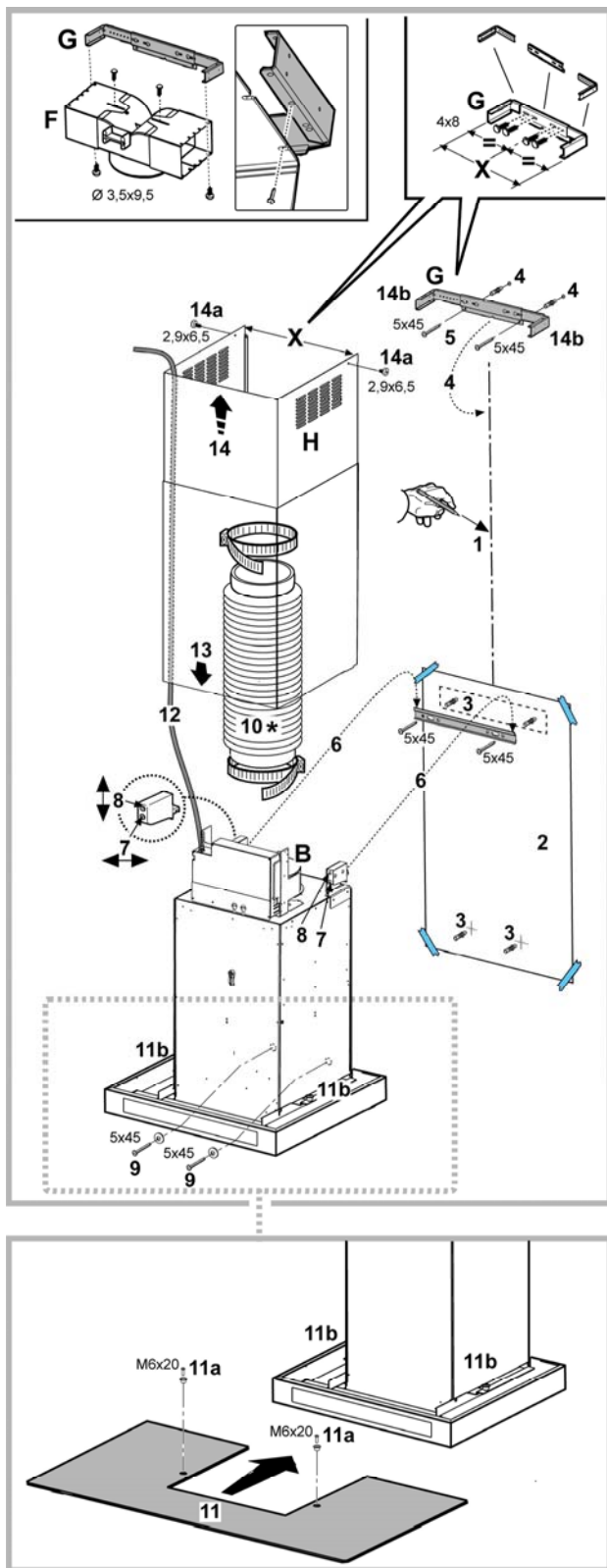

Preliminary information for installing the hood:

Disconnect the power supply at the domestic main switch before carrying out electrical connections.

Remove the grease filter/s.

1. Using a pencil, draw the centre line on the wall up to the ceiling to facilitate installation operations.
2. Apply the drilling template to the wall: Align the vertical centre-line on the drilling template with the centre-line drawn on the wall. The template's bottom edge represents the bottom edge of the hood.
3. Place the lower support bracket on the hole diagram so that it matches the dotted rectangle, mark the two external holes and drill.

Note: Drill all the holes indicated on the template: the top 2 holes are for hanging the hood and the bottom holes (generally 1 central or 2 side holes) are for fixing it securely to the wall.

Remove the hole diagram, insert the wall plugs and fix the hood support bracket with two 5 x 45 mm screws.

4. Fit the flue support bracket "G" to the wall and against the ceiling, use the support bracket as a hole diagram (if present, the small slot on the support must match the line drawn on the wall), mark 2 holes with the pencil then drill the holes (\varnothing 8 mm) and finally insert 2 plugs.
5. Fix the flue support bracket to the wall with two 5 x 45 mm screws.
6. Hook the hood to the lower bracket.
7. Adjust the distance between the hood and the wall.
8. Adjust the hood horizontally.
9. Fix the hood securely to the wall (**ABSOLUTELY NECESSARY!!**).
10. Connect an exhaust pipe (pipe and clamps are not supplied and must be bought separately) to the collar located above the extraction motor unit. For extractor operation, connect the other end of the exhaust pipe to the home discharge device. For filter operation, fix the deflector F to the flue support bracket G and connect the other end of the exhaust pipe to the deflector collar F.
11. Insert the steam deflector and secure it to the supports (11b) on the extractor unit with 2 bushings and 2 screws (11a).
12. Make all necessary electrical connections.
13. Fit the flues over the extractor unit, engaging them in their seat above the hood.
14. Slide the top section of the flue and secure it with 2 screws (14a) to the flue support bracket "G" (14b). Refit the grease filter/s and check for correct hood operation.

Description of the appliance





EN





Control panel











Calibrating the control panel





When the plug is inserted (or after a blackout) the system calibrates the keys; during calibration all the luminous display parts flash. Calibration lasts 15". All the display parts stop flashing at the end of calibration.



 **Off/Stand by:** the On condition is obtained by pressing  for 3 seconds; in this case keys  and  are enabled, the display point and the blue led of the relative keys light up. The Off condition is obtained by pressing  again for 3 seconds.







 **On/Off lights:** press  to switch on the lights, which turn amber. Contemporaneously the symbols at the sides  and  turn blue: the intensity of the light can be increased and diminished with these. Once the luminosity has been set, pressing  rapidly again memorises it (the symbol turns blue) and the light switches off.

 **On/Off motor:** press  to switch the motor on. It turns amber. Contemporaneously the symbols at the sides  and  as well as  turn blue. Press  or  to adjust the intensity of suction. Pressing  again switches the motor off and the last speed set is memorised.

 **Intensive timing:** by pressing this key the suction of the hood becomes intensive for a maximum time of 5 minutes. At the end the hood returns to the speed previously set. To exit from the function earlier press

 or one of the following keys:   or .

 **Fats filter signal:** this symbol (red led) lights up after 40 hours. Reset the signal by pressing  for a long time (at least 3 seconds) until the beep confirms it.

 **Carbon filter signal action.** This signal is shown only if it has been previously set. Proceed as follows: press  with the hood in Off: first  turns red, after about 1 second  also turns red. If you want to eliminate the carbon filter signal previously set, press  with the hood in Off. Reset the carbon filter signal (after 160 hours) by pressing  for a long time (about 3 seconds, until the beep).

Operation

! We advise switching the hood on, at minimum power, before beginning to cook to favour the optimal expulsion of odours. In addition we advise turning it off every time 10/15 minutes after finishing cooking.

! We advise frying under the hood only under constant supervision.

! It is forbidden to cook flambé under the hood because there is the risk of causing a fire.

The best performance of the apparatus is obtained with external expulsion: we advise using the hood in this version if possible.

External exhausting version

In this case the fumes are conveyed outside by means of a special pipe connected with the connection ring located on top of the hood.

Attention! The exhausting pipe is not supplied and must be purchased apart.

Diameter of the exhausting pipe must be equal to that of the connection ring = 150mm.

In the horizontal runs the exhausting pipe must be slightly slanted (about 10°) and directed upwards to vent the air easily from the room to the outside.

Attention! If the hood is supplied with active charcoal filter, then it must be removed.

Filtering version

One active charcoal filter is needed for this and can be obtained from your usual retailer.

The filter removes the grease and smells from the extracted air before sending it back into the room through the upper outlet grid.

Maintenance

EN

! It is always necessary to isolate the hood from the power supply during cleaning and maintenance. Therefore remove the plug.

We recommend carrying out maintenance regularly (about every 10 days) to ensure efficacious and constant performance of the hood.

Cleaning

The cooker hood should be cleaned regularly (at least with the same frequency with which you carry out maintenance of the fat filters) internally and externally. Clean using the cloth dampened with neutral liquid detergent. Do not use abrasive products. **DO NOT USE ALCOHOL!**

WARNING: Failure to carry out the basic cleaning recommendations of the cooker hood and replacement of the filters may cause fire risks.

Therefore, we recommend observing these instructions. The manufacturer declines all responsibility for any damage to the motor or any fire damage linked to inappropriate maintenance or failure to observe the above safety recommendations.

Cleaning the grease filters

Traps cooking grease particles.

This must be cleaned once a month (or when the filter saturation indication system – if envisaged on the model in possession – indicates this necessity) using non aggressive detergents, either by hand or in the dishwasher, which must be set to a low temperature and a short cycle.

When washed in a dishwasher, the grease filter may discolour slightly, but this does not affect its filtering capacity.

Remove the filter holder frame by turning the knobs (g) 90° that affix the chimney to the cooker hood.

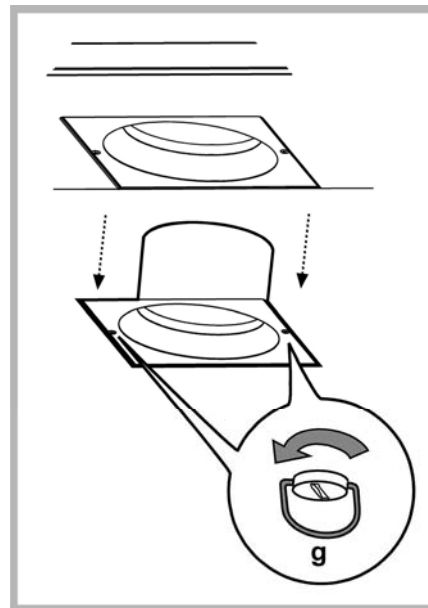

Cleaning the carbon filter

It absorbs unpleasant odours caused by cooking.

The charcoal filter can be washed once every two months (or when the filter saturation indication system – if envisaged on the model in possession – indicates this necessity) using hot water and a suitable detergent, or in a dishwasher at 65°C (if the dishwasher is used, select the full cycle function and leave dishes out).

Eliminate excess water without damaging the filter, then put it in the oven for 10 minutes at 100° C to dry completely. Replace the mattress every 3 years and when the cloth is damaged.

Mounting and changing the filter

Assembly

Place the mat around the grease filter and fix it in place using the devices provided.

Position the upper cap and fix it in place using the fixing pin.

To disassemble, perform the steps in the reverse order.

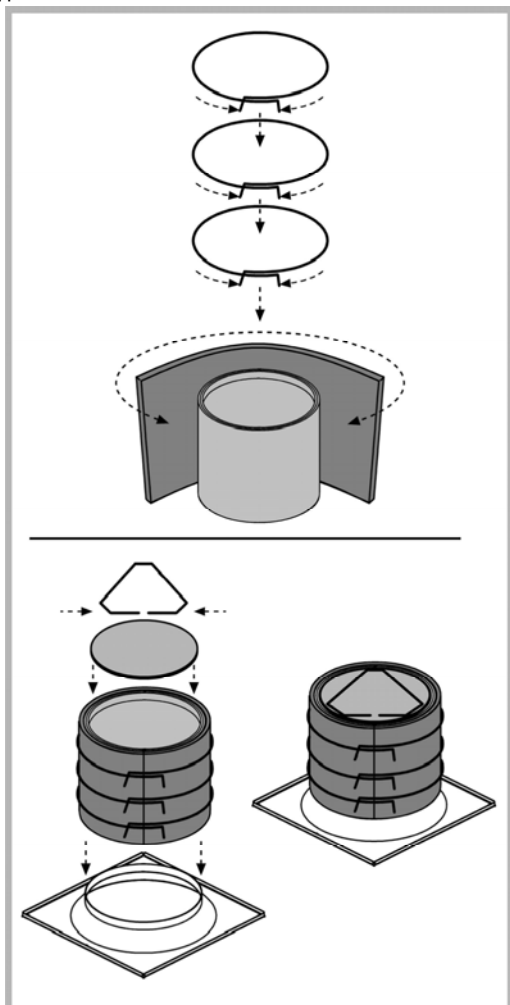

Replacing lamps

Disconnect the hood from the electricity.

Warning! Prior to touching the light bulbs ensure they are cooled down.

1. Using a flat head screwdriver or equivalent tool, carefully pry loose the light cover.
2. Remove the damaged light and replace with a new 12 Volt, 20 Watt (Maximum) halogen light made for a G-4 base SUITABLE FOR USE IN OPEN LUMINAIRES. Follow package directions and do not touch new light with bare hands.
3. Reinstall the light cover. (it will snap shut).

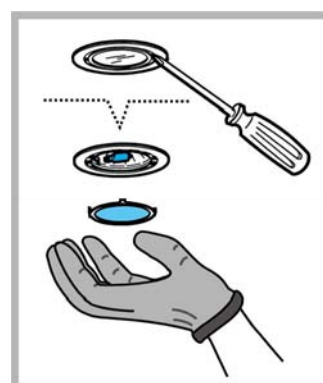

Caution

EN

General safety

- ! Do not connect the appliance to the mains until the installation is fully complete.
- ! Before any cleaning or maintenance operation, disconnect the hood from the mains by removing the plug or disconnecting the home mains switch.
- ! The appliance is not intended for use by children or persons with impaired physical, sensorial or mental faculties, or if lacking in experience or know-how, unless they are under supervision or have been trained in the use of the appliance by a person responsible for their safety.
- ! Children should be monitored to ensure that they do not play with the appliance.
- ! Never use the hood without effectively mounted grating.!
- ! The hood must NEVER be used as a support surface unless specifically indicated.
- ! The premises must be sufficiently ventilated, when the kitchen hood is used together with other gas combustion devices or other fuels.
- ! The suctioned air must not be conveyed into a conduit used for the disposal of the fumes generated by appliances that combust gases or other fuels.
- ! The flaming of foods beneath the hood itself is severely prohibited.
- ! The use of exposed flames is detrimental to the filters and may cause a fire risk, and must therefore be avoided in all circumstances.
- ! Any frying must be done with care in order to make sure that the oil does not overheat and burst into flames.
- ! As regards the technical and safety measures to be adopted for fume discharging it is important to closely follow the relations provided by the competent authorities.
- ! The hood must be regularly cleaned on both the inside and outside (AT LEAST ONCE A MONTH, it is in any event necessary to proceed in accordance with the maintenance instructions provided in this manual)..
- ! Failure to follow the instructions as concerns hood and filter cleaning will lead to the risk of fires.
- ! Do not use or leave the hood without the lamp correctly mounted because of the possible risk of electric shocks.
- ! We decline any responsibility for any problems, damage or fires caused to the appliance as the result of the non-observance of the instructions included in this manual.

Disposal

- Disposing of the packaging material: keep to the local regulations so that the packaging can be re-used.
- ! In case of anomalies apply to the authorized technical assistance service and require original spare parts.
- ! The information and technical data are subject to change and the producer, in line with technical progress, maintains the right to make modifications that he considers necessary without prior notice.

This appliance is marked according to the European directive 2002/96/EC on Waste Electrical and Electronic Equipment (WEEE). By ensuring this product is disposed of correctly, you will help prevent potential negative consequences for the environment and human health, which could otherwise be caused by inappropriate waste handling of this product.



The symbol  on the product, or on the documents accompanying the product, indicates that this appliance may not be treated as household waste. Instead it shall be handed over to the applicable collection point for the recycling of electrical and electronic equipment. Disposal must be carried out in accordance with local environmental regulations for waste disposal.

For more detailed information about treatment, recovery and recycling of this product, please contact your local city office, your household waste disposal service or the shop where you purchased the product.